

Haier®

User's Manual

LE42H5000

LE47H5000

LE55H5000

Please READ this manual carefully before operating your TV, and retain it for future reference.

Contents

Safety Warnings	2	Cloud Functions	18
Welcome	2	Cloud Functions.....	18
Important Information.....	2	All Apps.....	19
Important Safety Instructions	3	Local File Browser.....	19
About Your LED LCD TV	5	Browser	19
Installing the Stand	5	Settings.....	20
Wall Mounting Installation.....	6	You Tube	21
Front Control Panel.....	7	Twitter	21
Back panel connections.....	8	Facebook.....	22
Get to Know Your Remote Control.....	9	Net FileBrowser.....	22
External Equipment Connections	10	Maintenance	22
Power source.....	10	Troubleshooting	22
Connecting to an Antenna or Cable Connection	10	Specification	23
Connecting to HDMI Device.....	11	Format	23
Connecting to an AV Device.....	12		
Connecting to an Audio Device.....	13		
Connecting to a PC.....	13		
Basic Receiving and Playing Operations	14		
Switching ON/OFF the TV set	14		
Choose the Input source	14		
Tuning Your TV	14		
Color System	14		
Sound System.....	14		
Channel Edit.....	15		
Fine Tune	15		
Manual Search.....	15		
Auto Search	15		
Using Your TV	16		
How to Select the TV Program	16		
How to Adjust Volume.....	16		
Adjusting Picture Settings	16		
Changing the Picture Setting	16		
If the TV is currently in the 2D mode.....	17		
If the TV is currently in the 3D mode.....	17		
Adjusting Sound Setting.....	17		
Changing the Sound Setting	17		
Setting Functions	18		

Safety Warnings

Welcome

Thanks for buying this 47"/55" LED Backlit Flat TV. This guide will help you to set up and begin using your TV.

Firstly, check the contents of your box with the parts checklist below:

- 42"/ 47"/ 55"LED Backlit Flat TV
 - Remote control
 - AAA battery x2
 - Instruction Manual
 - TV Stand
 - 8Xscrews for 42"model ; 8x screws for 47" model(Plastic Trayx2,only for 47");
 - AV adaptor
 - 3D glasses x6
- Now you can get started!

Important Information

READ ALL INSTRUCTIONS BEFORE USE AND KEEP FOR FUTURE REFERENCE.

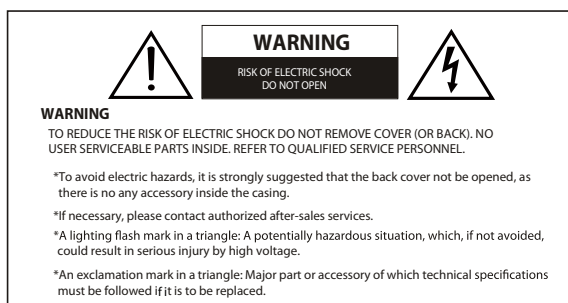

WARNING: To avoid fire or electric hazards, never place your television receiver in an area with heavy moisture. Attention should be paid to avoid accidental scratches or impacts onto the screen. The ventilation should not be impeded by covering the ventilation openings with items, such as newspaper, table-cloths, curtains, etc.

- CAUTION:**
- The main plug is used as disconnect device which shall remain readily operable.
 - Please read this manual carefully before using your television and keep this manual in a good place for future reference.
 - To achieve the best performance of your television, read this User's Manual carefully and properly store it for future reference.
 - Information of screen displays and figures in the User's Manual may vary due to technical innovations.
 - Unauthorized disassembly of this product is prohibited.



WARNING To prevent the spread of fire,keep candles or other open flames away from this product at all times.

Important Safety Instructions

The product should be tightly fixed to avoid drop damages and even fire.

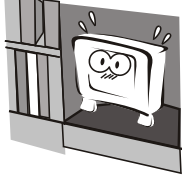

To avoid fire hazards, do not use this product under direct sunlight or closely to heat sources.

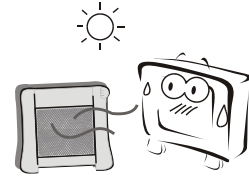

Do not locate the product close to water or oil, which may cause fire hazards.

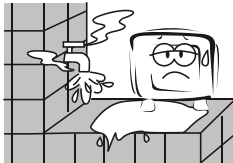

Unplug the power supply and antenna of the product when there is a rainstorm, especially Thunderstorm.

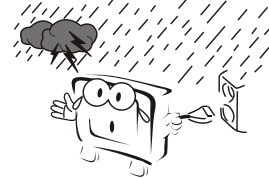

Do not use damaged or worn electric plugs, and keep electric cord away from heat sources to avoid electric shocks or fire hazards.



Do not connect excessive sockets in parallel or share the same socket by multiple plugs to avoid fire hazards.

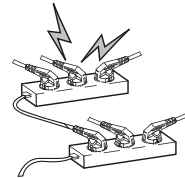

The product must be placed on a solid and stable surface to avoid collapse.

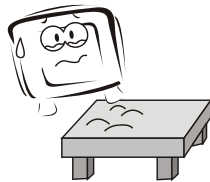

Unauthorized disassembly of the television is prohibited to avoid electric shocks or fire hazards. Contact authorized after-sales service if technical service is needed.

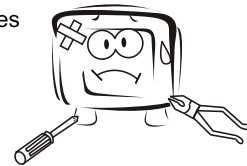

Keep the product away from a transformer or heat source to avoid fire hazards.

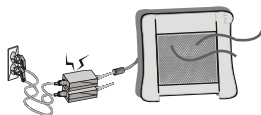

Disconnect the product from power supply and contact authorized after-sales service if abnormal sound is heard in the product.

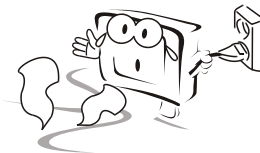

Don't use or store inflammable materials near the product to avoid explosion or fire hazards.

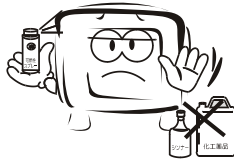

Don't place the product in a humid area to avoid fire hazards.

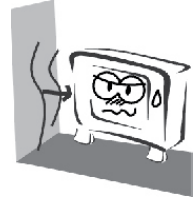

The antenna of the product should be away from electric cable to avoid electric shocks.

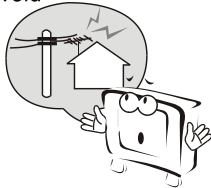

Never touch the plug when your hand is wet as this might cause electric shocks.

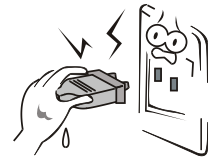

Always make sure that the television is well plugged as poor electric connection might cause fire.

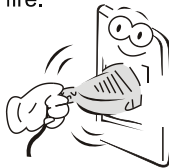

When antenna is used, measures should be taken to prevent water from flowing down along the cable into the television.



Unplug the television, use soft fabric, never chemicals, if you are going to make cleaning of the product. Make sure that no water drops in the product.

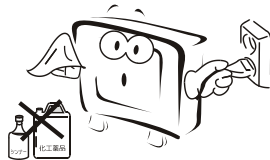

The plug and electric cable must be kept clean to avoid electric shocks or fire hazards.

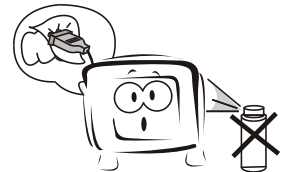

Disconnect the television from power supply and antenna when there is a rainstorm or thunderstorm to avoid electric shocks or fire hazards.



Disconnect the television from power supply to avoid electric shocks or fire hazards in a long vocation.

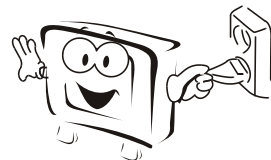

About Your LED LCD TV

Installing the Stand

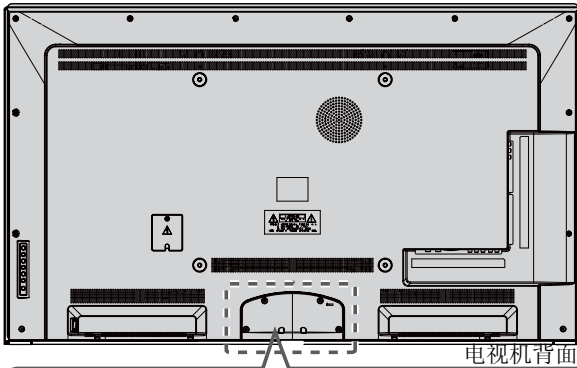

Step 1 : Connect the guide stand to the stand using 4 screws(M 4X8) as shown.

Step 2 : Remove 4 EA screws on back of TV as shown in picture.

Step 3: Put the stand base on the slot of display bottom; Finally fix 4 screws(M 4X12) in accessory to the right position as shown in picture.

Step 4: Stand assembly is finished.

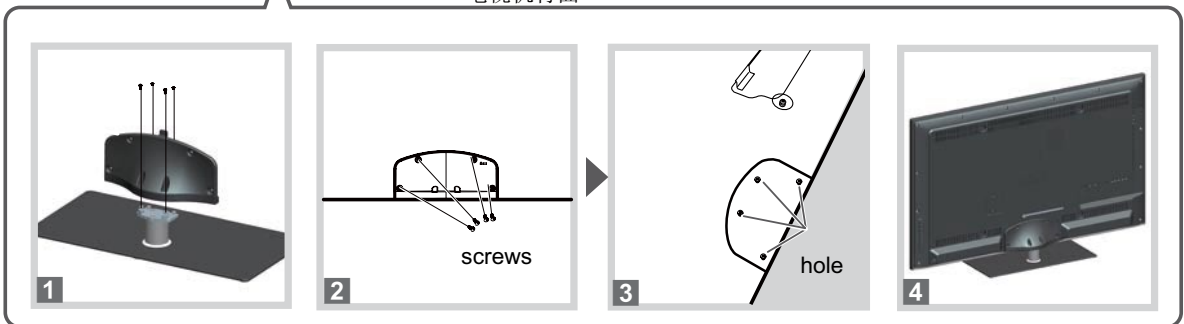

Wall Mounting Installation

Preparing before installing Wall-Mount.

To install a wall-mount from another manufacturer, use the Holder-Ring.

42" model standard screw : M6

47" model standard screw : M6

55" model standard screw : M6

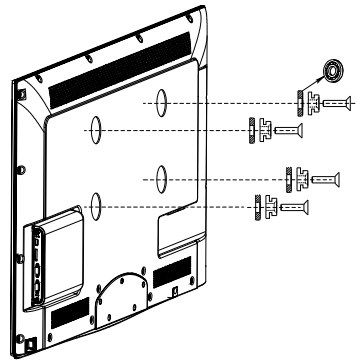

Installing Wall-Mount kit

The wall mount kit (Sold separately) allow you to mount the TV on the wall.

For detailed information on installing the wall mount see the instructions provided with the wall mount. Contact a technical assistance when installing the wall mount bracket. Haier Electronics is not responsible for any damage to the product or injury to yourself or others if you elect to install the TV on your own.

Front Control Panel

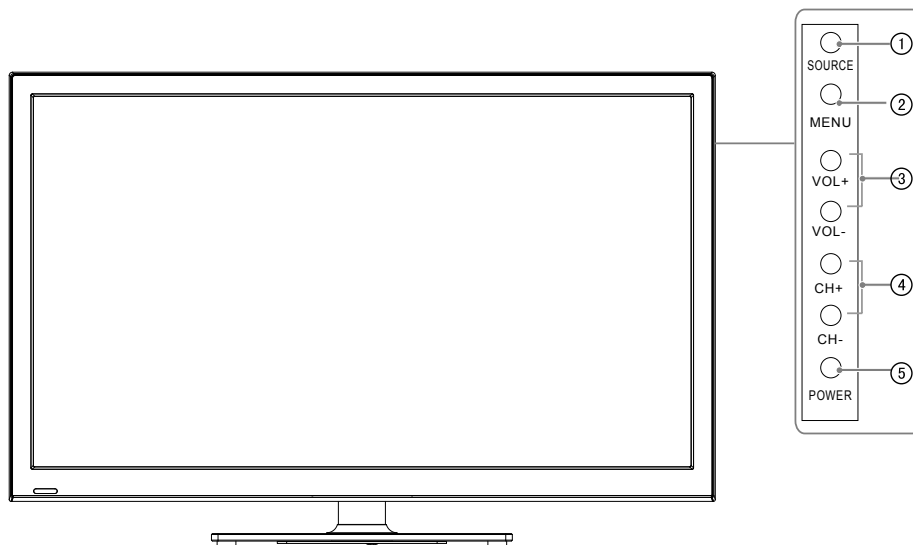

①	SOURCE	Press this key to open/close signal source options menu.
②	MENU	Menu display. Press to access the on-screen menu display.
③	VOL+/-	Press to increase and decrease the volume.

④	CH+/-	TV channel up and down.
⑤	POWER	Press to turn the TV on and off.

Back panel connections

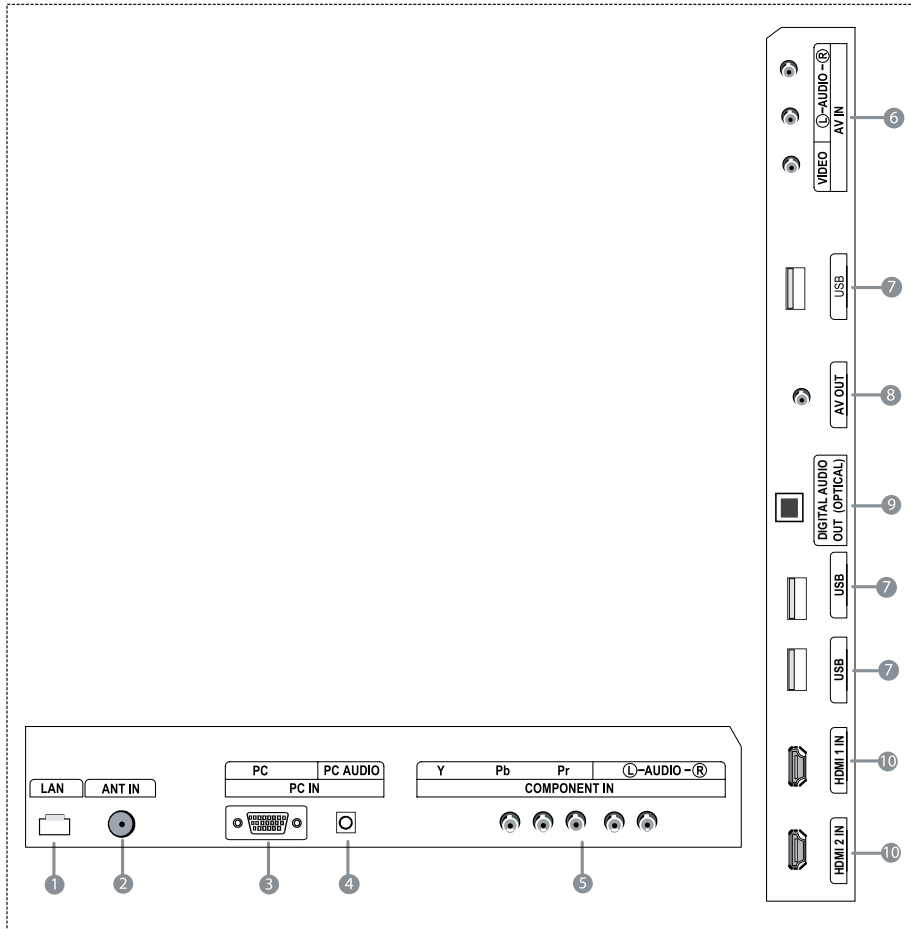

①	LAN	input
②	ANT IN	input
③	PC Video IN	input
④	PC Audio IN	input
⑤	COMPONENT IN	input
⑥	AV IN	input
⑦	USB	input

⑧	AV OUT	output
⑨	DIGITAL AUDIO OUT (OPTICAL)	output
⑩	HDMI 1 IN/HDMI 2 IN	input

Get to Know Your Remote Control

When using the remote control, aim it towards the remote sensor on the TV.

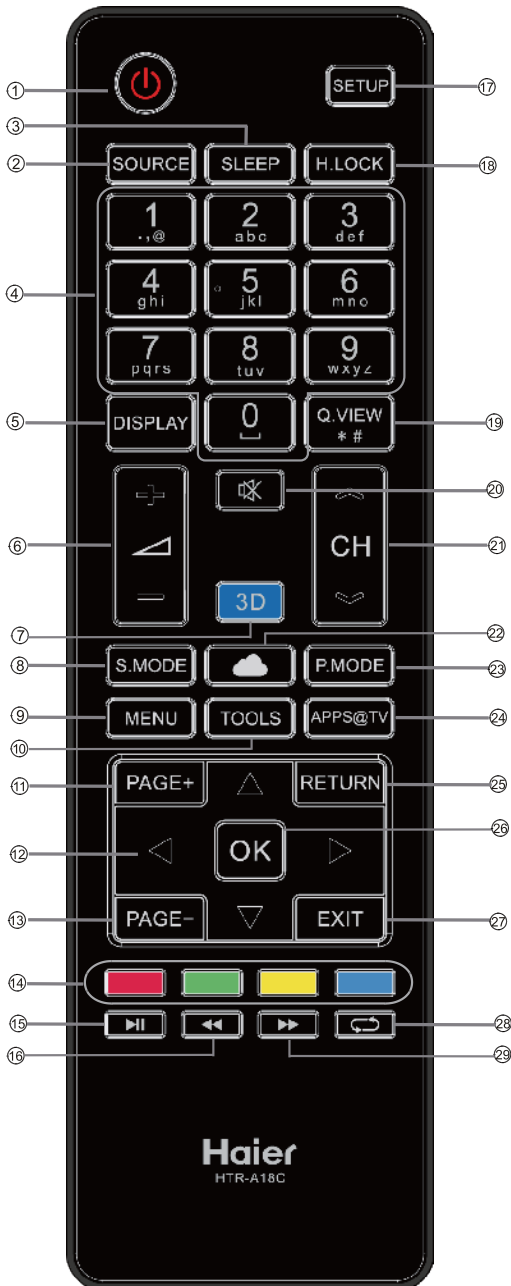

- ① Turn the TV on and off.
- ② Quick button switch to TV source.
- ③ sleep button.
- ④ Press to directly access to channels.
- ⑤ Display the channel list on the screen.
- ⑥ Adjust the Volume.
- ⑦ Quick button for 3D functions.
- ⑧ Quick button for Sound Mode function.
- ⑨ Displays the main on- screen menu.
- ⑩ No available.
- ⑪ Turn previous.
- ⑫ Selects the on-screen menu items and changes the values on the menu.
- ⑬ Turn next.
- ⑭ Function button (just reference the OSD).
- ⑮ Play/Pause button (only for USB).
- ⑯ Fast Reverse (only for USB).
- ⑰ Enter setting interface.
- ⑱ Hotel Lock.
- ⑲ Press to jump back and forth between two channels.
- ⑳ Cut off the sound temporarily.
- ㉑ Change Channels.
- ㉒ Quick button for Cloud functions.
- ㉓ Select the Picture Mode.
- ㉔ APPS@TV (TV-APPS homepage).
- ㉕ Returns to the previous menu.
- ㉖ OK button.
- ㉗ Exit the menu.
- ㉘ No available.
- ㉙ Fast Forward (only for USB).

External Equipment Connections

Power source

To use AC Power Supply

Use the AC polarized line cord provided for operation on AC. Insert the AC cord plug into a standard polarized AC outlet.

Note

- Never connect the AC line cord plug to other than the specified voltage. Use the attached power cord only.
- If the polarized AC cord does not fit into a non-polarized AC outlet, do not attempt to file or cut the blade. It is the user's responsibility to have an electrician replace the obsolete outlet.
- If you cause a static discharge when touching the unit and the unit fails to function, simply unplug the unit from the AC outlet and plug it back in. The unit should return to normal operation.

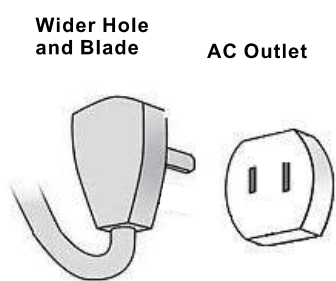

Polarized AC Cord Plug

Connecting to an Antenna or Cable Connection

Over-the-air TV reception quality will depend on your antenna type, antenna location and antenna positioning.

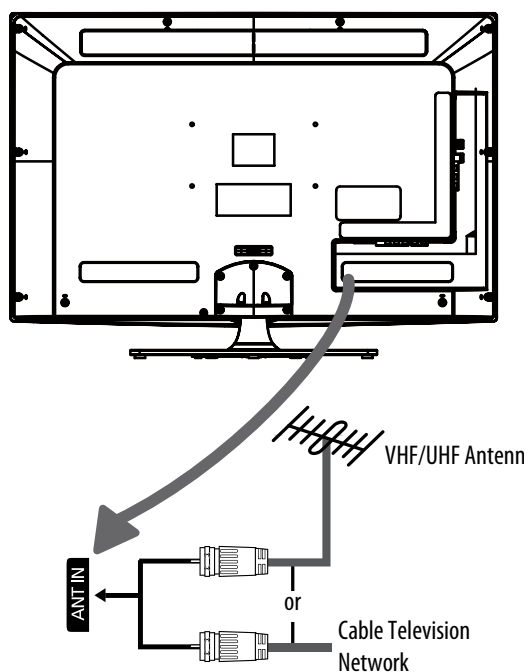

Note

- To improve the picture quality in a poor signal area, please purchase a signal amplifier and install properly.
- If the antenna needs to be split for two TV's, install a "2-Way Signal Splitter".
- When you move or swivel the TV with Antenna cable tightly connected, there is high risk antenna jack on TV will be broken off.

Choose Your Connection

There are several ways to connect your television, depending on the components you want to connect and the quality of the signal you want to achieve. The following are examples of some different ways to connect your TV with different input sources.

Connecting to HDMI Device

Using an HDMI or HDMI/DVI Cable: HD connection(up to 1080p)

We recommend using the HDMI connection for the best quality HD picture.
Available devices: DVD player, Blu-ray player, HD cable box, HD satellite receiver(STB).

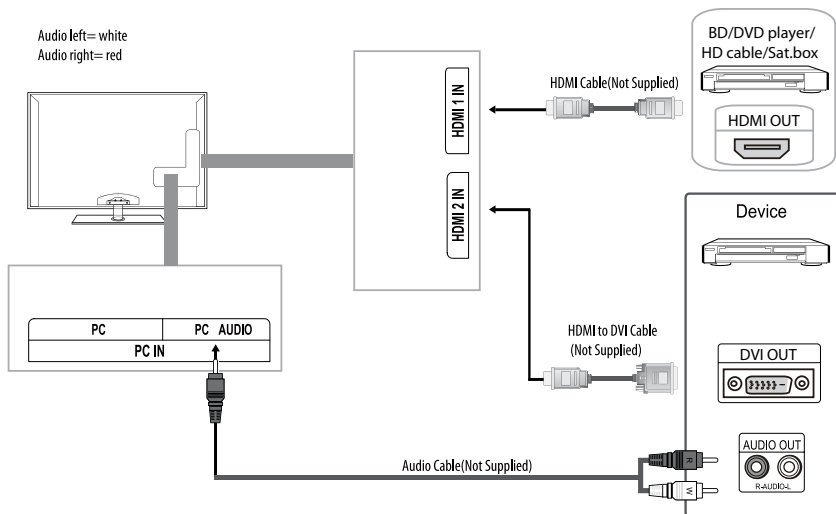

HDMI IN PC AUDIO IN

- 1 When using an HDMI/DVI cable connection, you must use the **HDMI IN** jack for video. A DVD player, Blu-ray player, HD cable box, HD satellite receiver (STB), cable box, or STB satellite receiver may require a DVI-HDMI (DVI to HDMI) cable or DVI-HDMI (DVI to HDMI) adapter. You must use the PC/DVI AUDIO IN jack for audio.
- 2 The picture may not display normally (if at all) or the audio may not work if you connect an external device that uses an older version of HDMI mode to the TV. If such a problem occurs, ask the manufacturer of the external device about the HDMI version and, if out of date, request an upgrade.
- 3 Be sure to purchase a certified HDMI cable. Otherwise, the picture may not display or a connection error may occur.

Connecting to an AV Device

Using a Component(up to 1080p) or an Audio/Video Cable

Available devices: DVD player,Blu-ray player,cable box,STB satellite receiver,VCR

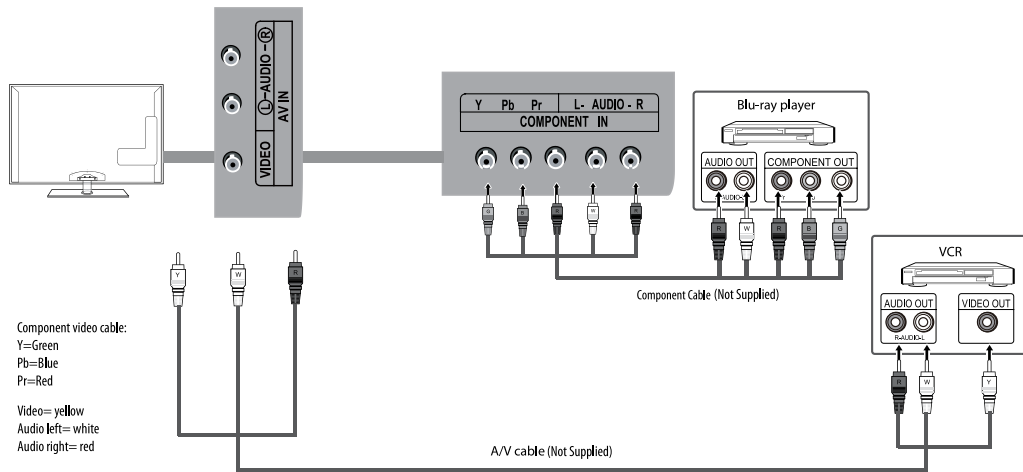

Note

- For better picture quality, the Component connection is recommended over the A/V connection.

AV OUT: Connects to the audio input jacks on your amplifier/home theater

- 1 When connecting, use the appropriate connector (included with your TV).
- 2 When you connect an audio amplifier to the AV OUT jacks: Decrease the volume of the TV and adjust the volume level with the Amplifier's volume control.

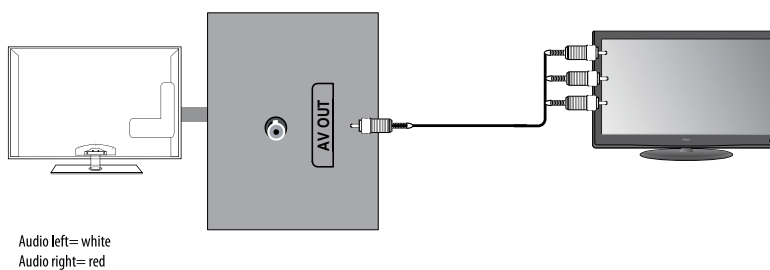

Connecting to an Audio Device

Using an Optical(Digital) or Audio(Analog) Cable Connection

Available devices: Digital Audio System, Amplifier, Home Theater.

When you connect a Digital Audio System to the DIGITAL AUDIO OUT (OPTICAL) jack: Decrease the volume of both TV and the system.

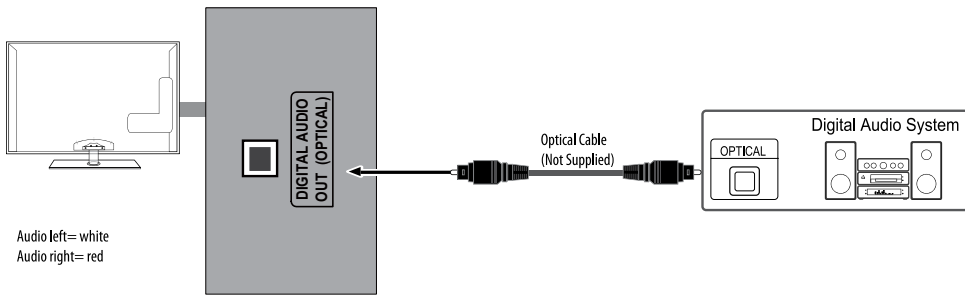

Connecting to a PC

Using an HDMI cable or HDMI to DVI Cable / a D-Sub Cable

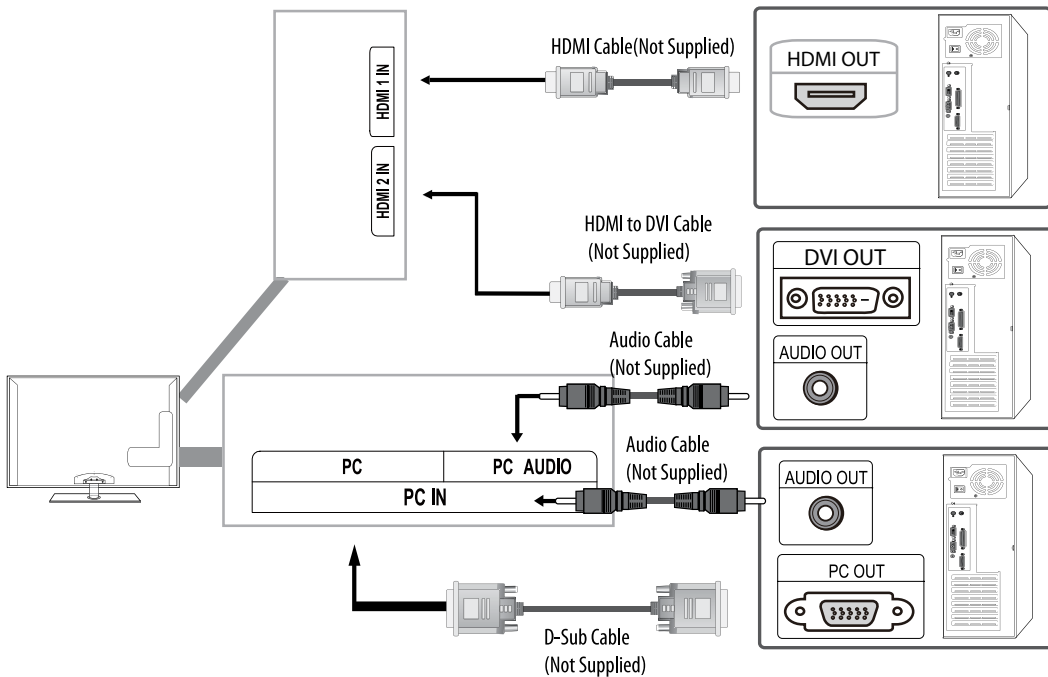

Note

□ Your PC may not support an HDMI connection.

Basic Receiving and Playing Operations

Switching ON/OFF the

TV set

In the manual, the OSD (on screen display) may be different from your TV's because it is just an example to help you with the TV operation.

Switching ON/OFF the TV set

- 1** First, connect power cord correctly and the power indicator will light.
- 2** Press **POWER** on the remote control.
- 3** If you want to exchange to standing by status, please press down **POWER** on the remote control
- 4** Disconnect the power supply or unplug the television if it is intended to completely cease the television performance.

Choose the Input source

Use to select TV or an external input source such as a DVD player/Blu-ray player/cable box/STB satellite receiver.

- 1** Press **SOURCE** button to enter the Input Source menu and then use \blacktriangle \blacktriangledown button to select the desired external input source (TV, AV, YPBPR, PC, HDMI1, HDMI2).
- 2** Press **OK** button to confirm .

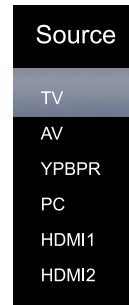

Tuning Your TV

Display Tuning menu by pressing **SOURCE** button then use \blacktriangle \blacktriangledown button to select the source of TV .

- 1** Press **MENU** button and then use \blacktriangleleft \blacktriangleright button to select **Tuning** menu. press **OK** to enter.
- 2** Press \blacktriangle \blacktriangledown button to select the desired items, press **OK** to enter its submenu.

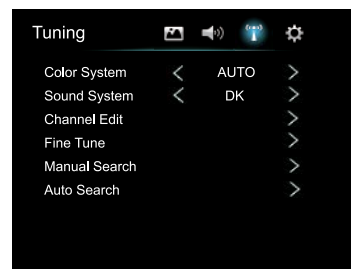

Color System

- 1** Press **MENU** button , Press \blacktriangleleft \blacktriangleright button to select **Tuning**, press **OK** to enter its submenu.
- 2** Press \blacktriangle \blacktriangledown button to select **Color System**, Press \blacktriangleleft \blacktriangleright button to select **PAL/NTSC/SECAM/AUTO**.
- 3** Press **RETURN** button to return to the previous menu, press **EXIT** button to exit the menu screen.

Sound System

- 1** Press **MENU** button , Press \blacktriangleleft \blacktriangleright button to select **Tuning**, press **OK** to enter its submenu.
- 2** Press \blacktriangle \blacktriangledown button to select **Sound System**, Press \blacktriangleleft \blacktriangleright button to select **DK/I/BG/M**.

- 3 Press **RETURN** button to return to the previous menu, press **EXIT** button to exit the menu screen.

Channel Edit

You can add a label to a channel to make it easier to find.

- 1 Press **MENU** button and then use **◀ ▶** button to select **Tuning** menu. press **OK** to enter its submenu.
- 2 Press **▲ ▼** button to select the **Channel Edit**, press **OK** to enter its submenu.

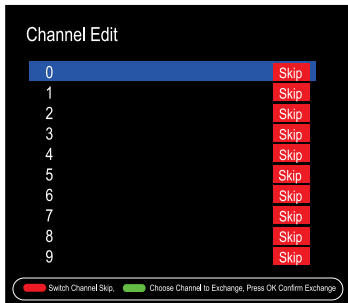

- 3 Press **▲ ▼** button to select the channel you want to edit . Press the **GREEN** button on the remote control, Choose the other Channels to Exchange, Press **OK** Confirm Exchange. If select the **RED** button ,the channel with a check icon is a skipped channel. Press **OK** button to display "please Input Channel Name", Select OK or Cancel. Press **EXIT** button to return to the previous menu.

Fine Tune

- 1 Press **MENU** button and then use **◀ ▶** button to select **Tuning** menu. press **OK** to enter its submenu.
- 2 Press **▲ ▼** button to select **Fine Tune**, Press **OK** button on the remote to enter its submenu.

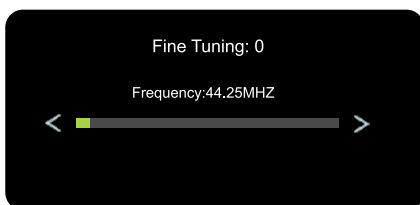

- 3 Press **◀ ▶** button to select your desired Frequency.

- 4 Press **EXIT** button to exit menu screen.

Manual Search

- 1 Press **MENU** button and then use **◀ ▶** button to select **Tuning** menu. press **OK** to enter its submenu.
- 2 Press **▲ ▼** button to select **Manual Search** , press **OK** to enter its submenu.
- 3 Press **◀ ▶** button to adjust the Frequency.
- 4 Press **MENU** button to return to the previous menu, press **EXIT** button to exit the menu screen.

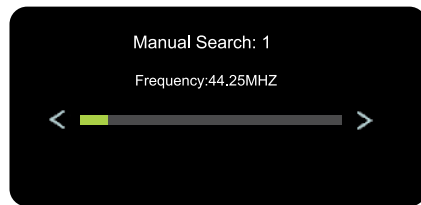

Auto Search

- 1 Press **MENU** button and then use **◀ ▶** button to select **Tuning** menu. press **OK** to enter its submenu.
- 2 Press **▲ ▼** button to select **Auto Search**, Press **OK** button on the remote to start to scan.
- 3 Press **MENU** button to return to the previous menu, press **EXIT** button to exit the menu screen.

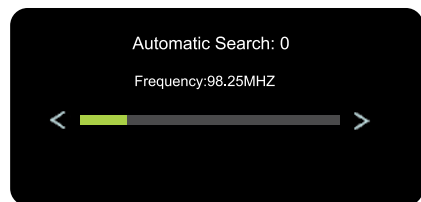

All channels now available will be automatically preset in older .After the search has finished, the first program number will display on the screen.

This search automatically adds only the active channels in your area to the TV's memory.

It deletes any channels on which there is no broadcast or a poor signal.

The channels found are automatically saved.

Using Your TV

How to Select the TV Program

- 1 Using Program number button Enter the channel number with the number keypad on the remote control.
- 2 Using **CH \wedge /CH \vee** button.
Press the **CH \wedge /CH \vee** button to select a channel number.

How to Adjust Volume

Press  button on the remote control or the keypad on the TV to adjust the volume level.

Adjusting Picture

Settings

Changing the Picture Setting

- 1 Press **MENU** button, then press $\leftarrow \rightarrow$ button to select **Picture**, press **OK** button to enter.

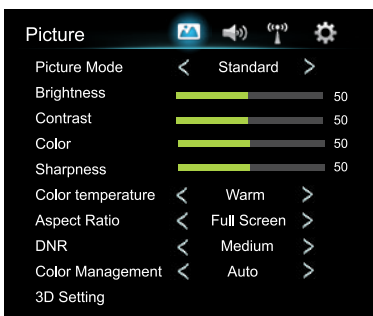

- 2 Press $\uparrow \downarrow$ button to select the item which requires to be adjusted.
- 3 Press $\leftarrow \rightarrow$ button to adjust the selected item.
- 4 When you are satisfied with your choice, press the **EXIT** button to return to normal viewing or press **RETURN** button to return to the previous menu.

❖ Picture Mode

This will select the picture mode. Select **Standard/Vivid/Soft/User**, according to the program.

❖ Brightness

This will adjust the light output of the complete picture, which will mainly affect the darker areas of the picture.

❖ Contrast

This will adjust the intensity of bright parts in the picture but keep the dark parts unchanged.

❖ Color

This will adjust the saturation level of the colors to suit your personal preference.

❖ Sharpness

This will adjust the sharpness of fine details in the picture.

❖ Color temperature

Press $\leftarrow \rightarrow$ button to set Color temperature as **Standard, Cool, Warm**.

This will increase or decrease **Warm** (red) and **Cool** (blue) colors to suit personal preferences. Select **Cool** to give the white color a blue tint, **Standard** to give the white color a natural tint, **Warm** to give the white color a red tint.

❖ Aspect Ratio

Press $\leftarrow \rightarrow$ button to set Advanced Ratio as **Panorama, Cinema, Zoom, JUST SCAN, FULL SCREEN, 4:3**.

❖ DNR

Press $\leftarrow \rightarrow$ button to set DNR as **AUTO, High, Off, Low, Medium**.

❖ Color Management

Press $\leftarrow \rightarrow$ button to set Colour Management as **Auto, On, Off**.

❖ 3D Setting

Ensure you read and understand the following safety information before using the TV's 3D function.



Note

- Some people may experience discomfort, such as dizziness, nausea and headaches, while viewing 3D TV. If you experience any such symptom, stop watching 3D TV, remove the 3D glasses and have a rest.
- Watching 3D images for an extended period of time may cause eye strain. If you feel that your eyes are becoming strained, stop watching 3D TV, remove your 3D glasses and have a rest.
- Do not allow children under 6 years old to view 3D images. A responsible adult should frequently check on children who are using the 3D function. If there are any reports of tired eyes, headaches, dizziness or nausea, stop the child from watching 3D TV and have a rest.
- Do not use the 3D glasses for other purposes (such as general spectacles, sunglasses, protective glasses etc.)
- Do not use the 3D function or 3D glasses while walking or moving around. If you use the 3D function or 3D glasses while walking or moving around you may run into objects, trip and/or fall and injure yourself.
- Do not drop, exert pressure on or step on the 3D glasses.
- Do not use the 3D glasses if they are cracked or broken.

- The TV doesn't store the 3D mode settings, so if you switch it off, it will return to 2D mode when turned back on again.
- In USB mode, there are various modes of 3D video sources. With USB signals, the 3D switch key only functions when playing a film. The TV will exit 3D mode when the film finished or when you manually exit 3D mode.

Adjusting Sound Setting

Changing the Sound Setting

- 1 Press **MENU** button.
- 2 Press **◀ ▶** button to select **Sound**, press **OK** button to enter.
- 3 Press **▲ ▼** button to select the item which require to be adjusted.
- 4 Press **◀ ▶** button to adjust the selection item.

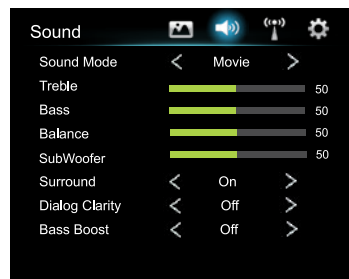

- 5 When you are satisfied with your choice, press the **EXIT** button to return to normal viewing or press **RETURN** button to return to the previous menu.

❖ **Sound Mode**

This sound setting can be adjusted to suit your personal preference. Select **Standard/Music/Movie/News/User** according to the program.

❖ **Treble**

Adjust to increase or decrease higher-pitched sounds.

❖ **Bass**

Adjust to increase or decrease lower-pitched sounds.

If the TV is currently in 2D mode,

- 1 Press the **3D** switch key on the remote to display the prompt menu.
- 2 Press **◀ ▶** button. You can then select a corresponding 3D mode.

If the TV is currently in 3D mode,

- 1 Press the **3D** switch key on the remote to display the prompt menu.
- 2 Press **◀ ▶** button to select 3D Mode off/2D>3D setup.

Note

- When you watch a 3D TV programme, please wear 3D glasses.

❖ **Balance**

Adjust to emphasize left or right speaker balance.

❖ **SubWoofer**

Adjust to increase or decrease subwoofer-pitched sounds.

❖ **Surround**

The surround sound feature expands the audio listening field wider and deeper to create exceptional sound quality from the TV's speakers.

❖ **Dialog Clarity**

Press ◀ ▶ button to set AVL as On or Off.(When Surround is set on, it's will appearance.)

❖ **Bass Boost**

Press ◀ ▶ button to set the SPDIF as On or Off.(When Surround is set on, it's will appearance.)

Setting Functions

- 1 Press **MENU** button.
- 2 Press ◀ ▶ button to select **Setting**, press **OK** button to enter.
- 3 Press ▲ ▼ button to select the item which require to be adjusted.
- 4 Press ◀ ▶ button to adjust the selected item.
- 5 When you are satisfied with your choice, press the **EXIT** button to return to normal viewing or press **RETURN** button to return to the previous menu.

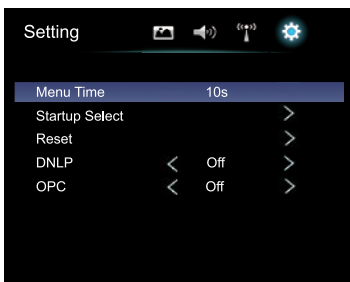
❖ **Menu Time**

Press ◀ ▶ button to select the number of minutes: To select 5s, 10s, 15s, 30s, 60s.

❖ **Startup Select**

Press ▲ ▼ button to select the Startup Select,

Press ◀ ▶ button to select Last Viewed /Navigator / Select Source.

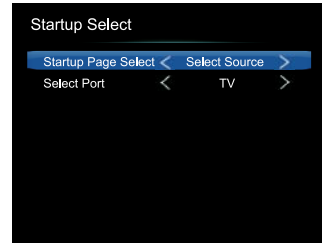

Press ▲ ▼ button to select Select Port, press ◀ ▶ to select TV/AV/YPbPr/PC/HDMI1/HDMI2.

❖ **Reset**

Press ◀ ▶ button to select OK or Cancel to Reset Factory Set.

❖ **DNL P**

Press ◀ ▶ button to select On/Off to auto regulation contrast or brightness.

❖ **OPC**

Press ◀ ▶ button to select On/Off to set OPC.

Cloud Functions

Cloud Functions

- 1 Press  button to enter Cloud interface.
- 2 Press ▲ ▼ ◀ ▶ button to select the icon which you required. Press **OK** to enter.
- 3 When you are satisfied with your choice, press **RETURN** button to return to the previous menu.



- 4 Press **MENU** button in this interface of Cloud stair menu, the OSD will display Wallpaper, Manage apps and System settings. You can press ▲ ▼ button and press **OK** button to select it.

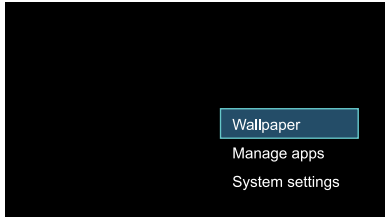

- 5 If you want to **Exit** Cloud functions, press **Exit** button.

All Apps

- 1 Press button to enter Cloud interface.
- 2 Press button to select **ALL Apps**. Press **OK** to enter.
- 3 Press button to select the item which require to be adjusted.



The **ALL Apps** contains all functions of Cloud, you can enter this submenu for example **Settings** by **ALL Apps**.

- 4 When you are satisfied with your choice, press **RETURN** button to return to the previous menu.

Local FileBrowser

- 1 Press button to enter Cloud interface.
- 2 Press button to select **Local FileBrowser**. Press **OK** to enter.
- 3 Press button to select the **USB STORAGE-SANDISK**. Press the corresponding key on the remote control to call out the prompt menu. (See Picture below).



- Photo: *. jpg, png etc.
- Music: *. Mp3(8-320kbps; WMA(32-192kbps); AAC(16-576kbps) etc.
- Movie:
 - MPEG4: *. avi files in accordance with Div*4. x/5. x Protocol;
 - MPEG2: some *. mpeg files;
 - MPEG1: *. dat and some *. mpeg files;
 - RealVideo ect.
- Text: *. Txt.





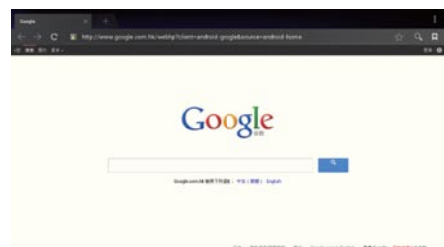

- 4 When you are satisfied with your choice, press **RETURN** button to return to the previous menu.

Browser

- 1 Press button to enter Cloud interface.
- 2 Press button to select the icon which you required. Press **OK** to enter.
- 3 Press the corresponding key on the remote control to call out the prompt menu. (See Picture below).
- 4 When you are satisfied with your choice, press **RETURN** button to return to the previous menu.





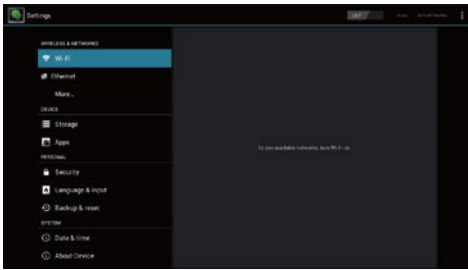

Settings

- 1 Press  button to enter Cloud interface.
- 2 Press     button to select **Settings**. Press **OK** to enter.
- 3 Press   button to select the item which require to be adjusted.



Connecting to a Wired Network

- 1 Press   button to select **Ethernet**, press **OK** to enter.
- 2 Press   button to select **DHCP** item, then press **Save** button, it will automatically finished.

You can set up your TV to access the Internet through your local area network (LAN) using a wired or wireless connection.

Connecting to a Wired Network. You can attach your TV to your LAN using a cable (cable not included) in three ways:

- You can attach your TV to your LAN by connecting the LAN port on the back of your TV to an external modem using a Cat 5 cable. See the diagram below:

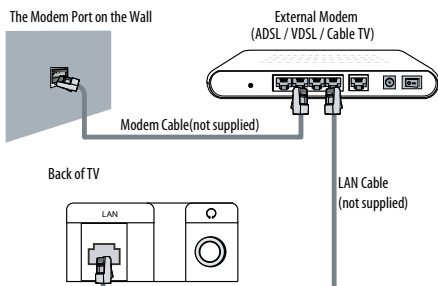

- You can attach your TV to your LAN by connecting the LAN port on the back of your TV to a router which is connected to an external modem. Use a Cat 5 cable for the connection. See the diagram below:

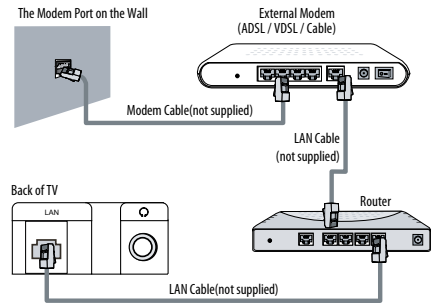



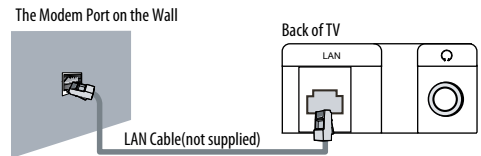



- Depending on how your network is configured, you may be able to attach your TV to your LAN by connecting the LAN port on the back of your TV directly to a network wall outlet using a Cat 5 cable. See the diagram below. Note that the wall outlet is attached to a modem or router elsewhere in your house.



Note

- The terminals (the position of the port and the type) of the external device may be different depending on the manufacturer.
- If the IP address allocation by the DHCP server has failed, turn the external modem off, turn it on again after at least 10 seconds and then try again.
- For the connections between the external modem and the router, refer to the owner's manual of the corresponding product.
- You can connect the TV to the LAN directly without connecting it through a router.
- You cannot use a manual-connection-type ADSL modem because it does not support DHCP. You have to use an automatic connection-type ADSL modem.

Connecting to a Wireless Network

- 1 Press   button to select **Wi-Fi**, press **OK** to enter, To see available networks, turn Wi-Fi On.
- 2 Press   button to select **Wireless Setting** item, press **OK** button to enter.
- 3 Press   button to select the network you need

and press **OK** button to enter.

- 4 Press **▲ ▼** button to select the **Network security key** and press **OK** button to enter .

- 5 Enter the password if necessary. Select **OK** to confirm.



To connect your TV to your wireless network, you need a wireless router or modem.



Note

- To use a wireless network, your TV must be connected to a wireless router. If the wireless router supports DHCP, your TV can use a DHCP or static IP address to connect to the wireless network.
- If the wireless router allows you to turn the Ping connection function on/off, turn it on.
- Select a channel for the wireless router that is not currently being used. If the channel set for the wireless router is currently being used by another device nearby, this will result in interference and communications may fail.
- This series include build-in Wi-Fi dongle, but Haier reserves the right to make changes without further notice to any products herein to improve reliability, function or design.

❖ DEVICE

Press **▲ ▼** button to select **Storage** or **Apps**. When select **Storage**, Press **OK** to enter, It's will display informations of USB. When you select **Apps**, press **OK** to enter and press **▶** button, then press **▲ ▼** button to select the item which you required.

❖ PERSONAL

Press **▲ ▼** button to select **Security/ Language&input / Backup&reset**. Press **OK** and press **▶** to enter. Press **▲ ▼** button to select the item which require to be adjusted.

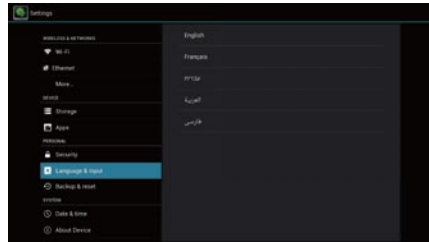

❖ SYSTEM

Press **▲ ▼** button to select **Date & Time/ About Device**. Press **OK** and press **▶** to enter. Press **▲ ▼** button to select the item which require to be adjusted.

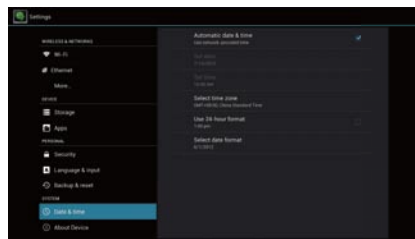

You Tube

- 1 Press **☁** button to enter Cloud interface.
- 2 Press **▲ ▼ ◀ ▶** button to select the icon which you required. Press **OK** to enter.
- 3 Press **▲ ▼** button to select the item which require to be adjusted.
- 4 When you are satisfied with your choice,press **RETURN** button to return to the previous menu.

Twitter

- 1 Press **☁** button to enter Cloud interface.

- 2 Press ▲ ▼ ◀ ▶ button to select the icon which you required. Press **OK** to enter.
- 3 Press ▲ ▼ button to select the item which require to be adjusted.
- 4 When you are satisfied with your choice,press **RETURN** button to return to the previous menu.

Facebook

- 1 Press  button to enter Cloud interface.
- 2 Press ▲ ▼ ◀ ▶ button to select the icon which you required. Press **OK** to enter.
- 3 Press ▲ ▼ button to select the item which require to be adjusted.
- 4 When you are satisfied with your choice,press **RETURN** button to return to the previous menu.

Net FileBrowser

Net File Browser is a standard that allows various consumer electronic devices to share connect with each other across a standard home network.This would allow a device such as a Net File Browser compatible television to play music or view videos or photos stored on a desktop computer or other compatible device.

- 1 Press  button to enter Cloud interface.
- 2 Press ◀ ▶ button to select **APPS**, Press **OK** button to enter.
- 3 Press ▲ ▼ ◀ ▶ button to select Net File Browser, then press **OK** button to play it.

Maintenance

Maintenance

Early malfunctions can be prevented. Careful and regular cleaning can extend the amount of time you will have your new TV. Be sure to turn the power off and unplug the power cord before you begin any cleaning.

Cleaning the Screen

- 1 Here's a great way to keep the dust off your screen for a while. Wet a soft cloth in a mixture of lukewarm water and a little fabric softener or dish washing detergent. Wring the cloth until it's almost dry, and then use it to wipe the screen.
- 2 Make sure the excess water is off the screen, and then let it air-dry before you turn on your TV.

Cleaning the Cabinet

To remove dirt or dust, wipe the cabinet with a soft, dry, lint-free cloth. Please be sure not to use a wet cloth.

Extended Absence

If you expect to leave your TV dormant for a long time (such as a vacation), it's a good idea to unplug the power cord to protect against possible damage from lightning or power surges.

Troubleshooting

For the sake of time and cost, it is strongly recommended that you checkout the problem by yourself according to the instructions listed hereunder before contacting the after-sales service for technical assistance.

Problem	Possible remedies
No picture, no sound	Turn on the power supply; Properly plug theTV setto the powersocket; Check to see if the power cable of other appliance is plugged in the TV set. Make sure that the power cable of the TV set is properly connected.
Problem	Possible remedies
Good picture, no sound	Depress the volume button; Check out the audio frequency input signals.
Failure of remote controller	Check to see if the remote controller display receiving window are blocked by other objects and if batteries are properly loaded.

No color, weak color or poor picture	Designate the item of color from the Picture menu and depress the volume button; Keep the display and VCR separate a reasonable space; Activate some functions to store picture brightness; Make sure that the display and signal source are available and turned on.
Excessive brightness or darkness	Adjust brightness or contrast.
Picture too big or small	Adjust the setup of sizes.
One speaker failure	Balance the sound in the menu.
Slight sound from display	It is a normal phenomenon.

Note

- Do not leave the television with static picture in an extended period as it may result in residual image on your television screen.

Note

- Production of the screen requires high and precision technologies. However, there might be some dark or bright (red, blue or green) spots, or some anomalous stripes or spots. This is not defect. If the TV set is used in an area 2,400 meters above the sea level where the air pressure is below 750hpa, the picture on the screen maybe affected and a muffled sound might be produced. These phenomena might happen in the area 1,500 meters above the sea level. This is resulted from difference between air pressures inside and outside the display. This is not a defect covered by the limited warranty.

Specification

Basic specification and parameter

Power	100-240V~ 50/60Hz
--------------	-------------------

Color System	PAL, NTSC, SECAM, AUTO
Video Input	USB,AV, Component, HDMI or PC,
Environmental condition	Operating temperature range: +5°C - +35°C Operating humidity range: 20%-80% Storage Temperature: -15°C~+45°C Storage Humidity: 5%-90%, non-condensing If the storage temperature is lower than 0 °C, please first lays the machine aside after in the operating temperature environment carries on restores 2 hours, then electrifies the use again, protects your television not to receive the damage.

Product main size (contain stand)

MODEL	Power Consumption	Net Size(LxWxH)	Net Weight
LE42H5000	120W	961x222x613mm	15.5Kg
LE47H5000	130W	1070x222x676mm	18.5Kg
LE55H5000	160W	1243x280x773mm	27Kg

Note

- Design and specifications are subject to change without notice. The dimension in this manual is a approximation.

Format

Recommendatory HDTV/

SDTV(YPbPr/YCbCr)format

Sequence Number	Format	Refresh Frequency (Hz)
1	480i/480p	60
2	576i/576p	50

3	720p	50/60
4	1080i/1080p	50/60

Recommendation PC connection input format

sequence number	Format	H-Frequency (KHz)	V-Frequency (Hz)
1	640*480@60Hz	31.5	60
2	800*600@60Hz	37.88	60
3	1024*768@60Hz (Recommendatory)	48.36	60

Recommendation DVI connection input format

Sequence Number	Resolution	Refresh Frequency (Hz)
1	640*480	60
2	800*600	60
3	1024*768	60

Recommendation HDMI connection input format

Sequence Number	Format	Refresh Frequency (Hz)
1	480i/480p	60
2	576i/576p	50
3	720p	50/60
4	1080i/1080p	50/60